

M23 FEMALE 0° 17POLE

PUR (3x(2x0,14D)+2x0,5+4x0.14+4x0,22)C 1m

Signal cable for SINAMICS S120 and motors with connection M23

Female straight

M23, 17-pole

with cable sleeves

Further cable lengths on request.

Plastic housings with good resistance against chemicals and oils.

The resistance to aggressive media should be individually tested for your application. Further details on request.

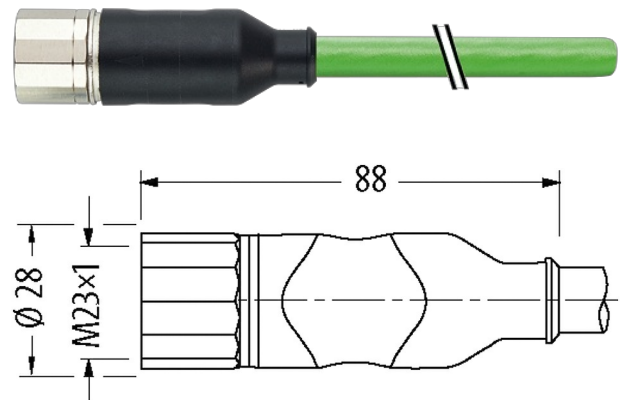
[Link to Product](#)**Illustration**

Product may differ from Image

Form

Form SS501

General data

Temperature range -25...+85 °C, depending on cable quality

Cables

Cable number 811

No./diameter of wires 3 × (2×0.14D) + 2 × 0.5 + 4 × 0.14 + 4 × 0.22)-C

Wire isolation PP (ye, gn, bk, br, rd, or, brrd brbl, gr, bl, whye, whbk, brye, brgr, gnbk, gnrd)

C-track properties 10 Mio.

Jacket Color green

Material (jacket) PUR (UL/CSA)

Outer Ø 9.5 mm ±5%

Bend radius (moving) 12× outer Ø

Temperature range (fixed) -50...+80 °C

Temperature range (mobile) -20...+60 °C

Shield yes

Bend radius (fixed) 10× outer Ø

Approval (cable) UL (AWM-Style 20236/1589), CSA; CE

Technical Data

Operating voltage max. 30 V AC/DC

Locking of ports Screw thread (M23×1 mm) recommended torque 2.0 Nm, self-securing

Compression gland	M23 (SW27)
Protection	IP65 and IP67 when plugged and screwed down (EN 60529)
Locking material	Brass, nickel plated
Material	PUR

Commercial data

country of origin	DE
customs tariff number	85444290
EAN	4048879485548
eClass	27279218
Packaging unit	1

Sketch

Female

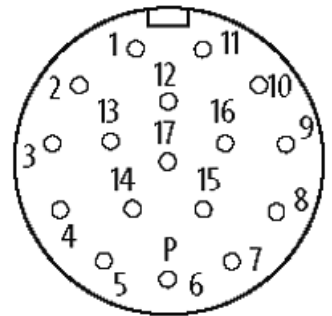

Product may differ from Image